

ASSEMBLY INSTRUCTIONS

VF47036MBL / VF47036MGN / VF47036MWT
VF47036MTK / VF47036MMP

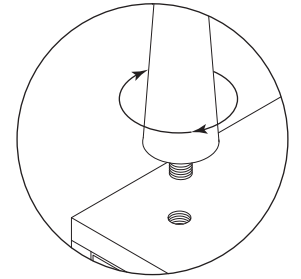

Step 1

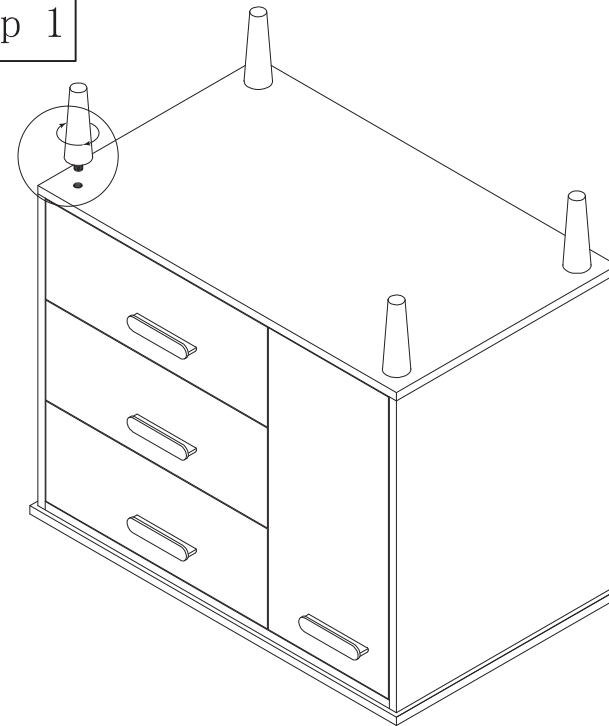

warning: Use two people to lift the vanity. Upon turning over the vanity upright, do not allow pressure to apply to one single leg or one single side.

Step 2

